

LPMS-URS3



LPMS Wired Miniature Motion Sensor / IMU / AHRS with RS232 and USB Connectivity

The LPMS-URS3 is an innovative and high performance miniature motion sensor. Integrating RS232 and USB interfaces into one unit, the LPMS-URS3 perfectly fits to both machine and human motion measurements for size and cost sensitive applications.



Key Features

- MEMS miniature inertial measurement unit (IMU)
- Integration of 3-axis gyroscope, accelerometer, magnetometer, temperature and barometric pressure sensor in one unit
- Real-time, on-device calculation of sensor orientation, linear acceleration and altitude
- Data output rates of up to 500Hz
- Variety of wired interfaces: RS232 and USB
- Control applications and SDK for Windows, Linux

Applications

- Manipulator balance control
- Internet of Things (IoT) devices
- Autonomous mobile robot navigation
- Robot arm control

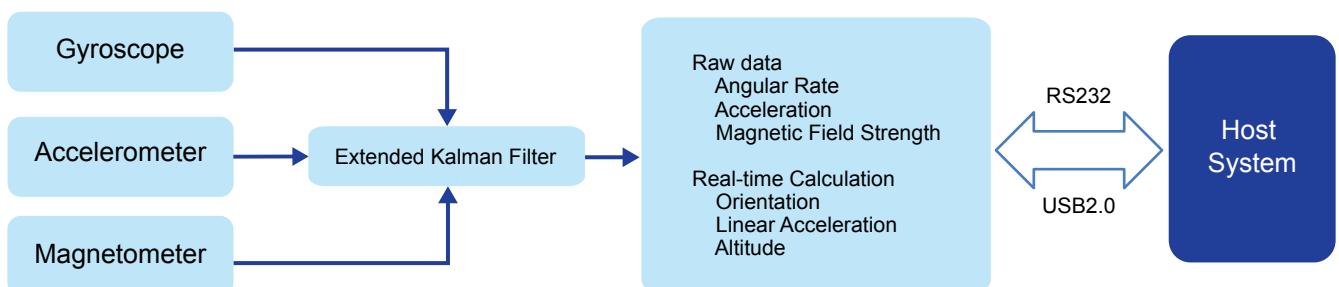

Sensor Specifications

Sensor Model	LPMS-URS3	
Dimensions	34×34.5×15.7mm	
Weight	17.6g	
Communication Interfaces	RS232	USB
Max. Baudrate	921.6Kbit/s	921.6Kbit/s
Communication Protocol	LP-BUS / ASCII	LP-BUS / ASCII
Orientation Range	Roll: ±180°; Pitch: ±90°; Yaw: ±180°	
Resolution	0.01°	
Accuracy	< 0.5° (Static), < 2°RMS (Dynamic)	
Accelerometer	3-axis, ±2 / ±4 / ±8 / ±16 g, 16bits	
Gyroscope	3-axis, ±125 / ±250 / ±500 / ±1000 / ±2000dps / ±4000dps, 16bits	
Magnetometer	3-axis, ±2 / ±8 gauss, 16bits	
Pressure Sensor	300-1100 hPa	
Data Output Format	Raw & Calibrated data, Euler Angle, Quaternion, Linear Acceleration	
Data Output Rate	500Hz	
Current Draw	~22mA	
Power Supply	5V ~36V DC	5V DC
Connector	Micro USB-B	DB9 female
Case Material	ABS	
Operating Temperature	-40~+80°C	
Software & Driver	LpmsControl2 interface software (Windows), Open source sensor driver for Windows and Linux (OpenZen, supports C, C++, Python, C#, Unity, ROS)	



Mechanical Drawing

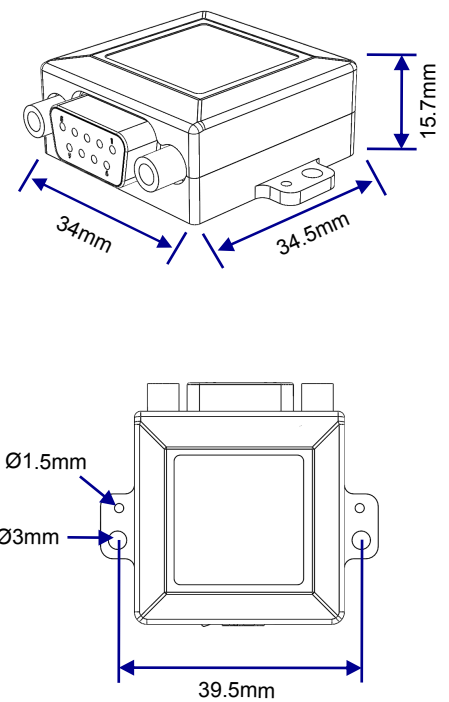

Package

- LPMS-URS3 Sensor x 1
- User guide card x1
- Cable x1
- Box x1
- Warranty (1 Year)



Interface Software

